

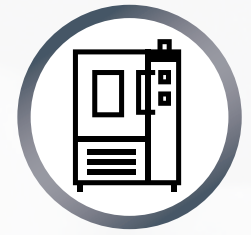

Environmental Test Equipment



Environmental Test Equipment



Temperature & Humidity Chamber



Satisfaction with the requirements of European regulations and guidelines.



Recognized as an excellent design product by the ministry of commerce, industry, and energy.



Conventional over temperature protection, a kind of backup device against electronic over temperature protection failure.



User safety by blocking potentially harmful UV light.



It memorizes the state of power failure and operates automatically when power is restored.



Real-time equipment monitoring and control system using mobile app.



More precise temperature control through temperature calibration.



Control of temperature / humidity / rpm / time, etc. through dedicated program.



Indicator to ascertain water level.



2 year warranty free A/S.



Eco-friendly product that has passed environmental impact assessment tests.



Electronic over temperature protection system.



PC communication via RS-232 / RS-485 / USB port.



Alarm if the water is low level.

General Application

Temperature and humidity chamber: Test for reliability, durability, climatic, freezing resistance, quality assurance, thermal endurance.

Pharmaceuticals stability test chamber: Stability test in accordance with ICH Guideline Q1A (R2) and Q1B (Option 2)

	Description	Temperature Range (°C / °F)	Humidity Range (%RH)	Volume (L / cu ft)	Model	Page
Small type	Tabletop type <ul style="list-style-type: none"> • Compact design Temp. & Humid. chambers • Continuous innovative model 	-40 to 150 / -40 to 302	20 ~ 95	25, 65, 100 / 0.9, 2.3, 3.5	TH3-KE	266
		-20 to 150 / -4 to 302	20 ~ 95	25, 65, 100 / 0.9, 2.3, 3.5	TH3-ME	266
		0 to 120 / 32 to 248	30 ~ 95	25, 65, 100 / 0.9, 2.3, 3.5	TH3-PE	266
Medium-large size type	Ultra-low temperature type (-70°C) <ul style="list-style-type: none"> • Wide control range for temperature and humidity • Differentiated structural mechanisms 	-70 to 150 / -94 to 302	25 ~ 95	189, 302, 408 / 6.7, 10.7, 14.4	TH-KH	270
	Low temperature type (-40°C) <ul style="list-style-type: none"> • Proven reliability and reproducibility • Optimized control system 	-40 to 150 / -40 to 302	25 ~ 95	189, 302, 408, 800, 1000, 1450 / 6.7, 10.7, 14.4, 28.3, 35.3, 57.1	TH-G	270
	General type <ul style="list-style-type: none"> • Stable temperature and humidity control for even during long-term continuous use 	-5 to 100 / 23 to 212	10 ~ 95 25 ~ 95	180, 314, 419, 770, 997, 1540 / 6.4, 11.1, 14.8, 27.2, 35.2, 54.4	TH-TG	275
	Dual chamber <ul style="list-style-type: none"> • Space-efficient with two chambers. • Independent temperature and humidity control of each chamber 	-5 to 100 / 23 to 212	20 ~ 90	150, 288, 384 (x 2 chamber) / 5.3, 10.2, 13.6 (x 2 chamber)	TH-DG	279
	Basic type <ul style="list-style-type: none"> • Dedicated controller with enhanced convenience • Improved water supply lines 	0 to 90 / 32 to 194	35 ~ 85	201, 398 / 7.1, 14.1	TH3-E	282
	Pharmaceuticals stability test <ul style="list-style-type: none"> • ICH Q1A (R2), Q1B (Option 2) • Dedicated lamp control system 	-5 to 85 / 23 to 185	20 ~ 85	300, 760 / 10.6, 26.8	TH-ICH	285
Room chamber type	Walk-in <ul style="list-style-type: none"> • Optimized temperature and humidity distribution with large room size walk-in chamber • Easy to use by optimizing the position of the control part according to the installation space and user requirements 					290
Custom type	Customized <ul style="list-style-type: none"> • Design and manufacture the customized Temp. & Humid. Chamber optimized by user requirements • Optimal customized equipment provided based on advanced technology and accumulated experience 					291

※ The contents of the above and the contents of this catalog may differ depending on the specific model and conditions of use. For the information about the features and specifications that applying to each models, please check the information on the corresponding page of each models.

Temperature & Humidity Chamber



Temperature & Humidity Chamber

Proven reliability and reproducibility Continuous innovative model

> Stable temperature and humidity distribution

Specialized internal circulation for fan/motor system structure.
Provides proven reproducibility and high reliability.

> Innovative external humidifier

Stable humidity control and maintains internal cleanliness with differentiated external humidification system.

> Complete chamber structure

Includes double-packing door.
Stable temperature control with excellent insulation and sealing.

> Minimal water consumption

Minimized refilling of water even for long-term high-humidity tests.
Efficient water supply and recirculation system.

Powerful & Useful Control Optimized precision control

> Intuitive operation with color touch display

Easy to understand operation of equipment and operation status with 5.6 inch color touch display controller.

> Powerful program operation

Provides diverse program operation environment with a maximum of 100 patterns and 2000 segments.

> Sophisticated custom control

PID zone subdivided into 6 zones for more precise control stability.

> Multi-functional dedicated software

Up to 32 devices can be controlled at same time.
Device operation and data processing function supported.



Ease of check the test status with LED display showing the operation condition.



Electronic over temperature shutdown system.



Controller for temperature and humidity control. (TH3-model)



Maximized usability with simple and useful functions

> Ease of check the test status

Convenient internal observation with LED lamp and looking glass window.
Figures out the operation state through displaying LED color even a long distance.

> Door lock with key lock

Door structure having well-sealed.
Included key lock features as standard.

> Provision of remote equipment monitoring service (option)

Real-time monitoring of equipment operation status using smartphone.
(when purchased LC GreenBox)

> Convenient moving and installation

Easy to move and install with casters.

More convenient and safe structure applied the highest grade safety system

> Electronic over temperature shutdown system

Independent precision temperature sensor and controller.
Provides more secure and reliable over temperature shutdown.

> General over temperature shutdown system

Backup device for electronic system failure.
Implementation of over-temperature shutdown even for electronic errors.

> Self-protection system

Protection system as like water tank shortage, door open warning, etc.
Over-current and short circuit breaking device.

> Protection features for refrigeration system

Protection system for overload and over temperature on refrigerator.
Stops automatically in case refrigerant pressure (high/low pressure) is abnormal.

※ Some of the above contents are limited to specific models.

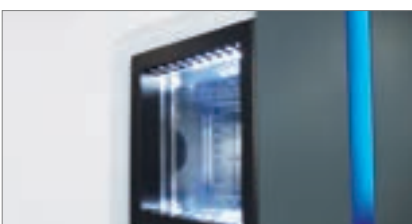

Tempered glass window with wire heater and LED lamp.



Door handle and locking device.



Ø50mm cable port and silicone plug included as standard.

Temperature & Humidity Chamber

Tabletop type

More convenience small type Temp. & Humid chamber with new advanced controller

Introduction video for TH chamber Tabletop type



TH3-ME

with Wire Shelves 2ea, Φ 50 Cable Port (standard), Stand (option)



▮ Optimized Model Configuration

- 3 series (KE, ME, PE) according to temperature and humidity control range.
TH3-KE; $-40 \sim 150^{\circ}\text{C}$ (20~95%RH)
TH3-ME; $-20 \sim 150^{\circ}\text{C}$ (20~95%RH)
TH3-PE; $0 \sim 120^{\circ}\text{C}$ (30~95%RH)
- Standard type Temp. & Humid chamber for selecting the optimized model according to test conditions.
- Dedicated stand for convenient use and moving. (option)
- Recorder for maintaining test records. (option)

▮ Structural Functional Features

- Proven reproducibility and reliability with structural design optimized for miniaturization.
- Compact design minimized foot space for excellent space saving.
- Accessible slim design to laboratories which have only 1-door entry.
- Stable humidity control ability with applying differentiated external humidification system and convenient maintenance for cleaning testing space.
- Excellent thermal insulation and sealing to ensure stable temperature and humidity reproducibility even for repeated test use.
- The door part has a double sealing structure and excellent airtightness.



Use Convenience Features

- Convenient operation with 5.6 inch color touch display controller.
- Possible to check the operation status with graphs.
- Water level check function enables water replenishment at the right time.
- Water inlet is easy to use with easy cap.
- Efficient water supply and recirculation system minimizes water refilling even for long-term high-humidity tests.
- Operation and status monitoring from the front of the chamber.
- Easy observation of samples with tempered glass door with built in heating wire and LED lamp.
- By displaying the operation status of the device with LED colors, convenient to identify chambers status from a far.
- The cable port and silicone plug included as standard make it convenient to connect external equipment.
- Easy to clean as it is easy to remove refrigerator condenser grill, making it convenient to maintain efficiency of refrigeration.



Color touch display controller (5.6 inches)



Indicator LED of operation condition

Multifunction Control System

- Storage and documentation of programs.
- Save program information and back up the set values.
- RS-232 port (default) and RS-485 port (option) supported.
- Control and data processing by connecting up to 32 devices to PC at same time via RS-485 port.
- Reliable control with temperature/humidity auto-tuning and temperature calibration.
- PID zone subdivided into 9 zones for more precise control stability.
- Monitor and control via mobile app anytime, anywhere with LC Connected. (mobile monitoring system) (when purchased LC GreenBox)
- Convenient checking with useful graph display.
- Save data as excel and text files.



Tempered glass window with wire heater and LED lamp

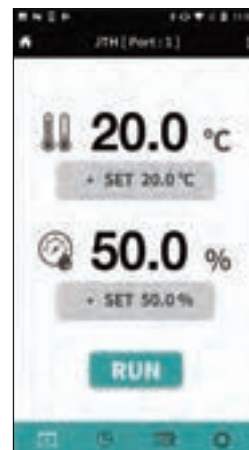

Remote monitoring and control via Lab Companion's app

Description	No.
Pattern	100
Repeat time	999
Part repeat time	255
Max. segments / pattern	100
Available max. segments	2000
Programmable process time / segment	99 hr. 59 min.

* It is possible to set 100 segments per pattern, but the maximum number of segments is not 10,000 (100 pattern x 100 segment) but 2,000.

▣ Outstanding Safety

- Electronic over temperature shutdown system.
(advanced over temperature (A-OT) limiter)
Independent precision temperature sensor and controller for safer and more accurate over temperature shutdown.
- General over power shutdown system.
(B-OT, backup over temperature limiter)
A backup device for electronic system failure, mechanically preventing over temperature even when it occurs electronic errors.
- Ensures that the surface temperature is kept below 60°C.
- Low and empty water level alarm and automatic shut off.
- Door open warning and automatic shut off.
- Overcurrent and short circuit protection of device.
- Fuse installed for each heater for safety.
- Auto stop when operating current of compressor is overloaded.

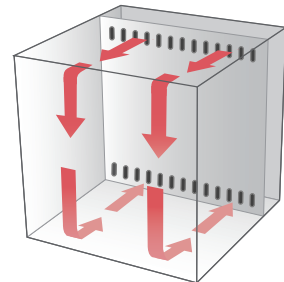
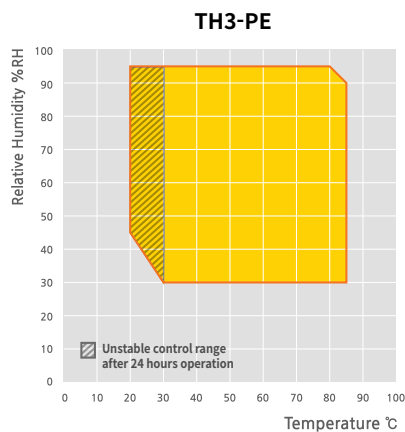
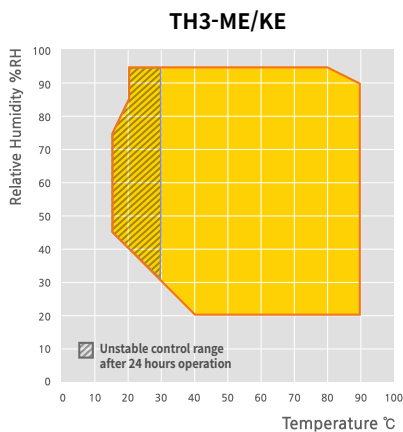

Specification

Model	TH3-KE-025	TH3-KE-065	TH3-KE-100	TH3-ME-025	TH3-ME-065	TH3-ME-100	TH3-PE-025	TH3-PE-065	TH3-PE-100
Interior dimensions									
Chamber volume (L / cu ft)	25 / 0.9	65 / 2.3	100 / 3.5	25 / 0.9	65 / 2.3	100 / 3.5	25 / 0.9	65 / 2.3	100 / 3.5
Width (mm / inch)	350 / 13.8	400 / 15.7	500 / 19.7	350 / 13.8	400 / 15.7	500 / 19.7	350 / 13.8	400 / 15.7	500 / 19.7
Depth (mm / inch)	220 / 8.7	330 / 13.0	380 / 15.0	220 / 8.7	330 / 13.0	380 / 15.0	220 / 8.7	330 / 13.0	380 / 15.0
Height (mm / inch)	350 / 13.8	495 / 19.5	530 / 20.9	350 / 13.8	495 / 19.5	530 / 20.9	350 / 13.8	495 / 19.5	530 / 20.9
Quantity of shelves (standard/max.)	2 / 7	2 / 10	2 / 10	2 / 7	2 / 10	2 / 10	2 / 7	2 / 10	2 / 10
Distance of between shelves (mm / inch)	20 / 0.8	20 / 0.8	20 / 0.8	20 / 0.8	20 / 0.8	20 / 0.8	20 / 0.8	20 / 0.8	20 / 0.8
Max. load per shelf (kg / lbs)	25 / 55.1	25 / 55.1	25 / 55.1	25 / 55.1	25 / 55.1	25 / 55.1	25 / 55.1	25 / 55.1	25 / 55.1
Permitted total load (kg / lbs)	65 / 143.3	65 / 143.3	65 / 143.3	65 / 143.3	65 / 143.3	65 / 143.3	65 / 143.3	65 / 143.3	65 / 143.3
Cable port (∅, mm / inch)	50 / 2.0	50 / 2.0	50 / 2.0	50 / 2.0	50 / 2.0	50 / 2.0	50 / 2.0	50 / 2.0	50 / 2.0
Water tank capacity (L / cu ft)	8 / 0.3	12 / 0.4	12 / 0.4	8 / 0.3	12 / 0.4	12 / 0.4	8 / 0.3	12 / 0.4	12 / 0.4
Weight (kg / lbs)	110 / 242.5	140 / 308.6	150 / 330.7	80 / 176.4	110 / 242.5	130 / 286.6	80 / 176.4	110 / 242.5	130 / 286.6
Temperature data									
Range without humidity (°C / °F)	-40 to 150 / -40 to 302	-40 to 150 / -40 to 302	-40 to 150 / -40 to 302	-20 to 150 / -4 to 302	-20 to 150 / -4 to 302	-20 to 150 / -4 to 302	0 to 120 / 32 to 248	0 to 120 / 32 to 248	0 to 120 / 32 to 248
Fluctuation (±°C / °F) ¹⁾	0.3 / 0.54	0.3 / 0.54	0.3 / 0.54	0.3 / 0.54	0.3 / 0.54	0.3 / 0.54	0.3 / 0.54	0.3 / 0.54	0.3 / 0.54
Variation (±°C / °F) ¹⁾	0.5 / 0.9	0.5 / 0.9	0.5 / 0.9	0.5 / 0.9	0.5 / 0.9	0.5 / 0.9	0.5 / 0.9	0.5 / 0.9	0.5 / 0.9
Heating time (min) ²⁾	60	60	60	50	50	50	40	40	40
Cooling time (min) ³⁾	70	70	70	55	55	55	35	35	35
Humidity data (※ Ref.: Temp./ Humid. control range graph)									
Range (%RH)	20 to 95	20 to 95	20 to 95	20 to 95	20 to 95	20 to 95	30 to 95	30 to 95	30 to 95
Fluctuation (±%RH) ¹⁾	1	1	1	1	1	1	1	1	1
Variation (±%RH) ¹⁾	3	3	3	3	3	3	3	3	3
Electrical data & Ordering information									
Electrical requirements (AC230V, 1ph, 50Hz, A)	12	13.9	15.8	-	-	-	-	-	-
Cat. No.	AAH824132K	AAH824232K	AAH824332K	-	-	-	-	-	-
Electrical requirements (AC230V, 1ph, 60Hz, A)	12	13.9	15.8	-	-	-	-	-	-
Cat. No.	AAH824131K	AAH824231K	AAH824331K	-	-	-	-	-	-
Electrical requirements (AC230V, 1ph, 50/60Hz, A)	-	-	-	7.7	9.6	13.8	7.2	9.4	10.5
Cat. No.	-	-	-	AAH821132K	AAH821232K	AAH821332K	AAH822132K	AAH822232K	AAH822332K

※ The above specifications are tested according to IEC 60068 standard.

※ Permissible environmental conditions are 18 - 30°C (recommended 20°C), 85%RH or less, under 2000m above sea level.

※ The DI water condition is pH 6.2 - 7.2 and the electrical conductivity is less than 20µs/cm.

1) The set value is set under the conditions of 25°C, 60%RH.

2) Heating time condition value: TH3-KE (-40°C to 100°C), TH3-ME (-20°C to 100°C), TH3-PE (0°C to 100°C)

3) Cooling time condition value: TH3-KE (20°C to -40°C), TH3-ME (20°C to -20°C), TH3-PE (20°C to 0°C)

Accessories Page 288 Cable Port, Shelves, Signal Lamp, Recorder, Water Purifier, Direct Water System, Stand, LC GreenBox

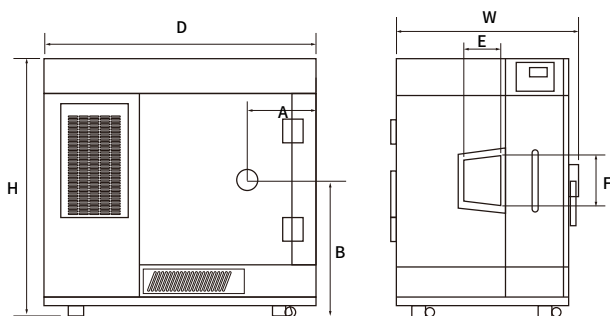

Dimension

Model	TH3-KE-025	TH3-KE-065	TH3-KE-100	TH3-ME-025	TH3-ME-065	TH3-ME-100	TH3-PE-025	TH3-PE-065	TH3-PE-100
W (mm / inch)	550 / 21.7	600 / 23.6	700 / 27.6	550 / 21.7	600 / 23.6	700 / 27.6	550 / 21.7	600 / 23.6	700 / 27.6
D (mm / inch)	880 / 34.6	1050 / 41.3	1110 / 43.7	880 / 34.6	1050 / 41.3	1110 / 43.7	880 / 34.6	1050 / 41.3	1110 / 43.7
H (mm / inch)	915 / 36.0	1060 / 41.7	1100 / 43.3	915 / 36.0	1060 / 41.7	1100 / 43.3	915 / 36.0	1060 / 41.7	1100 / 43.3
A (mm / inch)	211 / 8.3	276 / 10.9	276 / 10.9	211 / 8.3	276 / 10.9	276 / 10.9	211 / 8.3	276 / 10.9	276 / 10.9
B (mm / inch)	495 / 19.5	580 / 22.8	580 / 22.8	495 / 19.5	580 / 22.8	580 / 22.8	495 / 19.5	580 / 22.8	580 / 22.8
E (mm / inch)	170 / 6.7	170 / 6.7	170 / 6.7	170 / 6.7	170 / 6.7	170 / 6.7	170 / 6.7	170 / 6.7	170 / 6.7
F (mm / inch)	229 / 9.0	229 / 9.0	229 / 9.0	229 / 9.0	229 / 9.0	229 / 9.0	229 / 9.0	229 / 9.0	229 / 9.0

Temperature & Humidity Chamber

Low temperature type (-70 ~ 150°C / -40 ~ 150°C)

General Temp. & Humid chamber with proven reliability and reproducibility

- **TH-KH** Ultralow temp. type (-70°C)
- **TH-G** Low temp. type (-40°C)



TH-G-180

with Wire Shelves 2ea, Φ 50 Cable Port (standard), Recorder (option)

Optimized Model Configuration

- Various models optimized according to temperature and humidity control range and specialized functions.
- TH-KH Series (-70~150°C, 25~95%RH)
Provides wide temperature control range.
- TH-G Series (-40~150°C, 25~95%RH)
Representative model with proven reliability.

Structural Functional Features

- Stable humidity control ability with applying differentiated external humidification system and convenient maintenance for cleaning testing space.
- Excellent thermal insulation and sealing to ensure stable temperature and humidity reproducibility even for repeated test use.
- Proven reproducibility and reliability with structural design optimized for each capacity.
- The door part is a double-sealed structure that provides enhanced airtightness.
- Durability even after long-term repeated use has been verified by satisfying the door load test (SEFA standard).



Use Convenience Features

- Efficient water supply and recirculation system minimizes water refilling even for long-term high-humidity tests.
- Drawer-type water tank structure makes refill the water easily at the front part.
- Possible structure to refill the water even during operation.
- Direct water supply system. (option)
- Easy observation of samples with tempered glass door with built in heating wire and LED lamp.
- Open/close door with latches on either side.
- Door handle with built-in key lock.
- Cable port (Ø50 mm) is included as standard, making it convenient to connect external equipment.
- Easy to clean as it is easy to remove refrigerator condenser grill, making it convenient to maintain efficiency of refrigeration.



Drawer-type water tank



Door handle and locking device

Multifunction Control System

- 5.7-inch color touch display controller for convenient intuitive operation and checking of operation status.
- Save program information and back up the set values.
- Includes temperature and humidity auto-tuning.
- Highly reliable control through temperature calibration.
- PID zone subdivided into 6 zones for more precise control stability.
- RS-232 port (default) and RS-485 port (option) supported.
- Control and data processing by connecting up to 32 devices to PC at same time via RS-485 port.
- Convenient checking with useful graph display.



Cable port



Tempered glass window with wire heater and LED lamp

Description	No.
Pattern	120
Repeat time	999
Part repeat time	255
Max. segments / pattern	100
Available max. segments	1200
Programmable Process time / segment	999 hr. 59 min.

* It is possible to set 100 segments per pattern, but the maximum number of segments is not 12,000 (120 pattern x 100 segment) but 1,200.

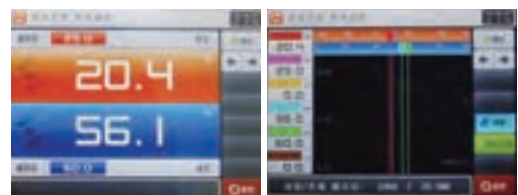

Controller (5.7 inch)

Temp. & humid. graph

▣ Outstanding Safety

- Electronic over temperature shutdown system (advanced over temperature. (A-OT) limiter)
Independent precision temperature sensor and controller for safer and more accurate over temperature shutdown.
- General over power shutdown system. (B-OT, backup over temperature limiter)
A backup device for electronic system failure, mechanically preventing over temperature even when it occurs electronic errors.
- Ensures that the surface temperature is kept below 60°C.
- Low and empty water level alarm and automatic shut off.
- Door open warning and automatic shut off.
- Overcurrent and short circuit protection of device.
- Fuse installed for each heater for safety.
- Auto stop when operating current of compressor is overloaded.
- Auto stop when compressor is overheating.
- Auto shut off in case refrigerant pressure (high/low pressure) is abnormal.

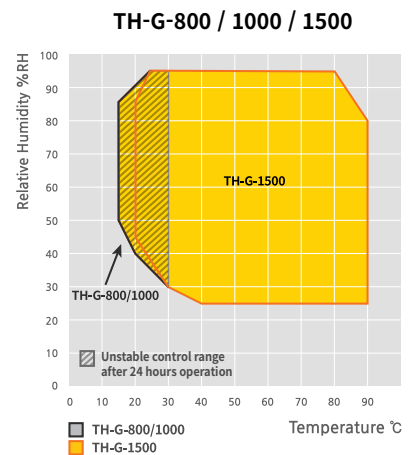
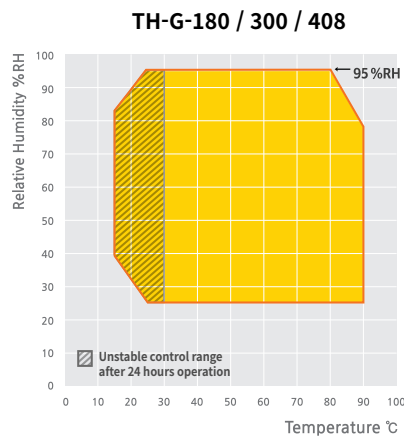
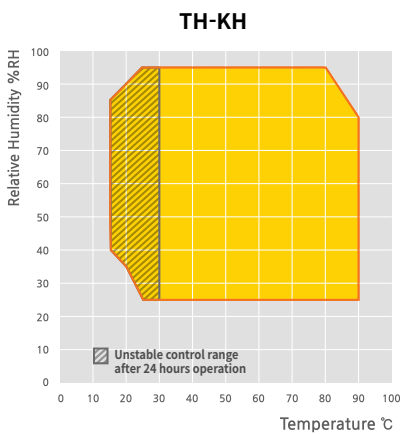
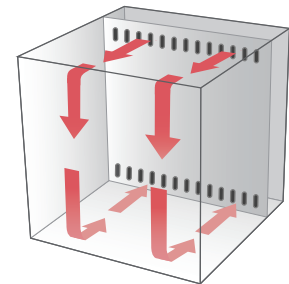

Specification

Model	TH-KH-180	TH-KH-300	TH-KH-408
Interior dimensions			
Chamber volume (L / cu ft)	189 / 6.7	302 / 10.7	408 / 14.4
Width (mm / inch)	500 / 19.7	600 / 23.6	600 / 23.6
Depth (mm / inch)	630 / 24.8	630 / 24.8	850 / 33.5
Height (mm / inch)	600 / 23.6	800 / 31.5	800 / 31.5
Quantity of shelves (standard/max.)	2 / 9	2 / 10	2 / 10
Distance of between shelves (mm / inch)	60 / 2.4	60 / 2.4	60 / 2.4
Max. load per shelf (kg / lbs)	20 / 44.1	25 / 55.1	25 / 55.1
Permitted total load (kg / lbs)	50 / 110.2	65 / 143.3	65 / 143.3
Cable port (∅, mm / inch)	50 / 2.0	50 / 2.0	50 / 2.0
Water tank capacity (L / cu ft)	15 / 0.5	15 / 0.5	15 / 0.5
Weight (kg / lbs)	320 / 705.5	385 / 848.8	410 / 903.9
Temperature data			
Range without humidity (°C / °F)	-70 to 150 / -94 to 302	-70 to 150 / -94 to 302	-70 to 150 / -94 to 302
Fluctuation (±°C / °F) ¹⁾	0.3 / 0.54	0.3 / 0.54	0.3 / 0.54
Variation (±°C / °F) ¹⁾	0.5 / 0.9	0.5 / 0.9	0.5 / 0.9
Heating time (-70°C to 120°C) (min)	70	70	70
Cooling time (20°C to -70°C) (min)	80	80	80
Humidity data (※ Ref.: Temp./ Humid. control range graph)			
Range (%RH)	25 to 95	25 to 95	25 to 95
Fluctuation (±%RH) ¹⁾	0.4	0.4	0.4
Variation (±%RH) ¹⁾	3	3	3
Electrical data & Ordering information			
Electrical requirements (380V, 3ph, 50Hz, A)	10.1	10.2	10.2
Cat. No.	AAHC3014K	AAHC3114K	AAHC3214K

※ The above specifications are tested according to IEC 60068 standard.

※ Permissible environmental conditions are 18 - 30°C (recommended 20°C), 85%RH or less, under 2000m above sea level.

※ The DI water condition is pH 6.2 - 7.2 and the electrical conductivity is less than 20µs/cm.

1) The set value is set under the conditions of 25°C, 60%RH.

Accessories Page 288

Cable Port, Shelves, Signal Lamp, Recorder, Water Purifier, Direct Water System, Inner Glass Door

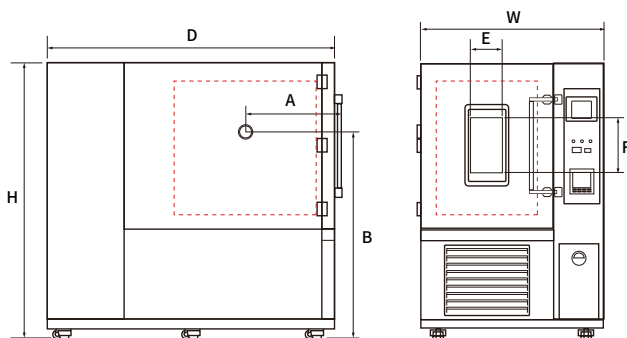

Dimension

Model	TH-KH-180	TH-KH-300	TH-KH-408
W (mm / inch)	1050 / 41.3	1150 / 45.3	1150 / 45.3
D (mm / inch)	1615 / 63.6	1615 / 63.6	1835 / 72.2
H (mm / inch)	1560 / 61.4	1760 / 69.3	1760 / 69.3
A (mm / inch)	550 / 21.7	550 / 21.7	670 / 26.4
B (mm / inch)	1225 / 48.2	1325 / 52.2	1325 / 52.2
E (mm / inch)	200 / 7.9	200 / 7.9	200 / 7.9
F (mm / inch)	330 / 13.0	330 / 13.0	330 / 13.0

Specification

Model	TH-G-180	TH-G-300	TH-G-408	TH-G-800	TH-G-1000	TH-G-1500
Interior dimensions						
Chamber volume (L / cu ft)	189 / 6.7	302 / 10.7	408 / 14.4	800 / 28.3	1000 / 35.3	1450 / 57.1
Width (mm / inch)	500 / 19.7	600 / 23.6	600 / 23.6	1000 / 39.4	1000 / 39.4	1100 / 43.3
Depth (mm / inch)	630 / 24.8	630 / 24.8	850 / 33.5	800 / 31.5	1000 / 39.4	1000 / 39.4
Height (mm / inch)	600 / 23.6	800 / 31.5	800 / 31.5	1000 / 39.4	1000 / 39.4	1450 / 57.1
Quantity of shelves (standard/max.)	2 / 9	2 / 10	2 / 10	2 / 14	2 / 14	3 / 18
Distance of between shelves (mm / inch)	40 / 1.6	40 / 1.6	40 / 1.6	40 / 1.6	40 / 1.6	40 / 1.6
Max. load per shelf (kg / lbs)	20 / 44.1	25 / 55.1	25 / 55.1	40 / 88.2	40 / 88.2	40 / 88.2
Permitted total load (kg / lbs)	50 / 110.2	65 / 143.3	65 / 143.3	100 / 220.5	100 / 220.5	100 / 220.5
Cable port (Ø, mm / inch)	50 / 2.0	50 / 2.0	50 / 2.0	50 / 2.0	50 / 2.0	50 / 2.0
Water tank capacity (L / cu ft)	15 / 0.5	15 / 0.5	15 / 0.5	15 / 0.5	15 / 0.5	15 / 0.5
Weight (kg / lbs)	320 / 705.5	385 / 848.8	410 / 903.9	620 / 1366.9	680 / 1499.1	860 / 1896.0
Temperature data						
Range without humidity (°C / °F)	-40 to 150 / -40 to 302	-40 to 150 / -40 to 302	-40 to 150 / -40 to 302	-40 to 150 / -40 to 302	-40 to 150 / -40 to 302	-40 to 150 / -40 to 302
Fluctuation (±°C / °F) ¹⁾	0.3 / 0.54	0.3 / 0.54	0.3 / 0.54	0.3 / 0.54	0.3 / 0.54	0.3 / 0.54
Variation (±°C / °F) ¹⁾	0.5 / 0.9	0.5 / 0.9	0.5 / 0.9	0.5 / 0.9	0.5 / 0.9	0.5 / 0.9
Heating time (-40°C to 120°C) (min)	60	60	60	70	70	90
Cooling time (20°C to -40°C) (min)	60	60	60	75	75	90
Humidity data (※ Ref.: Temp./ Humid. control range graph)						
Range (%RH)	25 to 95	25 to 95	25 to 95	25 to 95	25 to 95	25 to 95
Fluctuation (±%RH) ¹⁾	0.4	0.4	0.4	1	1	2
Variation (±%RH) ¹⁾	3	3	3	3	3	3
Electrical data & Ordering information						
Electrical requirements (230V, 1ph, 50Hz, A)	25.2	25.6	25.6			
Cat. No.	AAH80013K	AAH80023K	AAH80033K	-	-	-
Electrical requirements (230V, 1ph, 60Hz, A)	25.2	25.6	25.6			
Cat. No.	AAH80011K	AAH80021K	AAH80031K	-	-	-
Electrical requirements (380V, 3ph, 50/60Hz, A)	9.1	9.2	9.2	12.2	12.2	15.5
Cat. No.	AAH80018K	AAH80028K	AAH80038K	AAH80048K	AAH80058K	AAH80078K

※ The above specifications are tested according to IEC 60068 standard.

※ Permissible environmental conditions are 18 - 30°C (recommended 20°C), 85%RH or less, under 2000m above sea level.

※ The DI water condition is pH 6.2 - 7.2 and the electrical conductivity is less than 20µs/cm.

1) The set value is set under the conditions of 40°C, 75%RH.

Accessories Page 288

Cable Port, Shelves, Signal Lamp, Recorder, Water Purifier, Direct Water System, Inner Glass Door

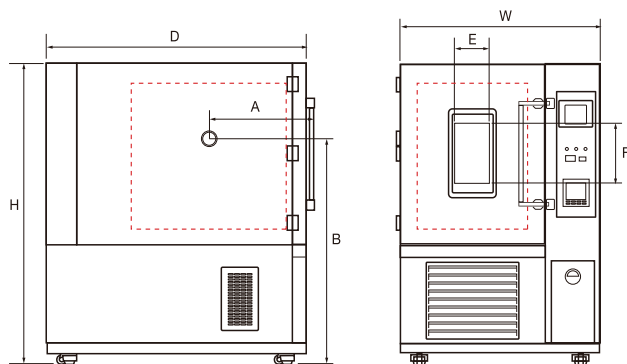

Dimension

Model	TH-G-180	TH-G-300	TH-G-408	TH-G-800	TH-G-1000	TH-G-1500
W (mm / inch)	1003 / 294.9	1103 / 434.3	1103 / 434.3	1503 / 591.7	1503 / 591.7	1503 / 591.7
D (mm / inch)	1139 / 448.4	1139 / 448.4	1359 / 535.0	1319 / 519.3	1519 / 598.0	2065 / 813.0
H (mm / inch)	1468 / 558.0	1668 / 656.7	1668 / 656.7	1968 / 774.8	1968 / 774.8	2007 / 790.2
A (mm / inch)	412 / 162.2	432 / 170.1	532 / 209.4	509 / 200.4	609 / 239.8	482 / 189.8
B (mm / inch)	1110 / 43.7	1246 / 49.1	1246 / 49.1	1465 / 57.7	1495 / 58.9	1500 / 59.1
E (mm / inch)	200 / 7.9	200 / 7.9	200 / 7.9	270 / 10.6	270 / 10.6	270 / 10.6
F (mm / inch)	330 / 13.0	330 / 13.0	330 / 13.0	330 / 13.0	330 / 13.0	330 / 13.0

Temperature & Humidity Chamber

General type (-5 ~ 100°C)

Stable control for long-term temperature and humidity tests



TH-TG-180

with Wire Shelves 2ea, Φ 50 Cable Port (standard), Recorder (option)



TH-TG-1500

with Wire Shelves 2ea, Φ 50 Cable Port (standard), Recorder, Signal Lamp (option)

Optimized For Long-term Testing

- Superior defrosting control technology ensures stable temperature and humidity control for long-term tests.
- Recommended in case no low temperature testing.
- 6 models up to 1500L depending on capacity.
- Satisfies ICH Guideline Q1A (R2) Stability Test.
- Recorder for maintaining test records. (option)
- Options available for convenient internal observation during long-term testing and access to samples under testing. (inner glass door and hand-in port)

Structural Functional Features

- Optimum temperature and humidity test can be carried out even with minimum refrigeration performance, it makes reduce the electric energy efficiently.
- Excellent thermal insulation and sealing to ensure stable temperature and humidity reproducibility even for repeated test use.
- Proven reproducibility and reliability with structural design optimized for each capacity.
- The door part is a double-sealed structure that provides enhanced airtightness.

Use Convenience Features

- Convenient operation with large color touch display controller.
- Efficient water supply and recirculation system minimizes water refilling even for long-term high-humidity tests.
- Drawer-type water tank structure makes refill the water easily at the front part.
- Possible structure to refill the water even during operation.
- Convenient checking the water level at the front of the chamber.
- Direct water supply system. (option)
- Easy observation of samples with tempered glass door with built in heating wire and LED lamp.
- Open/close door with latches on either side.
- Door handle with built-in key lock.
- Cable port (Ø50 mm) is included as standard, making it convenient to connect external equipment.
- Easy to clean as it is easy to remove refrigerator condenser grill, making it convenient to maintain efficiency of refrigeration.



Drawer-type water tank



Door handle and locking device

Multifunction Control System

- Save program information and back up the set values.
- Includes temperature and humidity auto-tuning.
- Highly reliable control through temperature calibration.
- PID zone subdivided into 9 zones for more precise control stability.
- RS-232 port (default) and RS-485 port (option) supported.
- Control and data processing by connecting up to 32 devices to PC at same time via RS-485 port.
- Convenient checking with useful graph display.



Cable port



Tempered glass window with wire heater and LED lamp

Description	No.
Pattern	100
Repeat time	999
Part repeat time	255
Max. segments / pattern	100
Available max. segments	2000
Programmable process time / segment	99 hr. 59 min.

* It is possible to set 100 segments per pattern, but the maximum number of segments is not 10,000 (100 pattern x 100 segment) but 2,000.



Controller

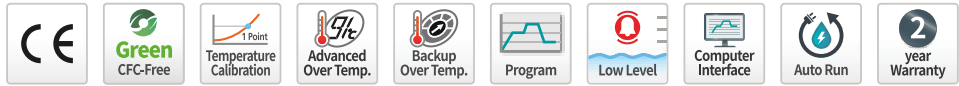

Outstanding Safety

- Electronic over temperature shutdown system (advanced over temperature (A-OT) limiter)
Independent precision temperature sensor and controller for safer and more accurate over temperature shutdown.
- General-type over power shutdown system. (B-OT, backup over temperature limiter)
A backup device for electronic system failure, mechanically preventing over temperature even when it occurs electronic errors.
- Ensures that the surface temperature is kept below 60°C.
- Low and empty water level alarm and automatic shut off.
- Door open warning and automatic shut off.
- Overcurrent and short circuit protection of device.
- Fuse installed for each heater for safety.
- Auto stop when operating current of compressor is overloaded.
- Auto stop when compressor is overheating.
- Auto shut off in case refrigerant pressure (high/low pressure) is abnormal.



TH-TG-180 / 300 / 408

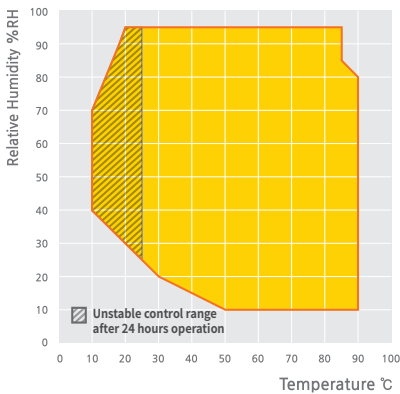

TH-TG-800 / 1000 / 1500

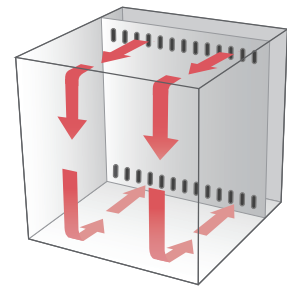
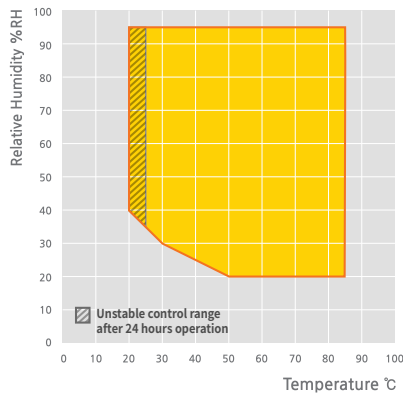

Specification

Model	TH-TG-180	TH-TG-300	TH-TG-408	TH-TG-800	TH-TG-1000	TH-TG-1500
Interior dimensions						
Chamber volume (L / cu ft)	180 / 6.4	314 / 11.1	419 / 14.8	770 / 27.2	997 / 35.2	1540 / 54.4
Width (mm / inch)	500 / 19.7	748 / 29.4	748 / 29.4	748 / 29.4	748 / 29.4	1100 / 43.3
Depth (mm / inch)	600 / 23.6	600 / 23.6	800 / 31.5	920 / 36.2	1190 / 46.9	1000 / 39.4
Height (mm / inch)	600 / 23.6	700 / 27.6	700 / 27.6	1120 / 44.1	1120 / 44.1	1400 / 55.1
Quantity of shelves (standard/max.)	2 / 7	2 / 8	2 / 8	2 / 17	2 / 17	2 / 17
Distance of between shelves (mm / inch)	60 / 2.4	60 / 2.4	60 / 2.4	60 / 2.4	60 / 2.4	60 / 2.4
Max. load per shelf (kg / lbs)	20 / 44.1	25 / 55.1	25 / 55.1	40 / 88.2	40 / 88.2	40 / 88.2
Permitted total load (kg / lbs)	50 / 110.2	65 / 143.3	65 / 143.3	100 / 220.5	100 / 220.5	100 / 220.5
Cable port (Ø, mm / inch)	50 / 2.0	50 / 2.0	50 / 2.0	50 / 2.0	50 / 2.0	50 / 2.0
Water tank capacity (L / cu ft)	15 / 0.5	15 / 0.5	15 / 0.5	15 / 0.5	15 / 0.5	15 / 0.5
Weight (kg / lbs)	220 / 485.0	250 / 551.2	280 / 617.3	360 / 793.7	410 / 903.9	480 / 1058.2
Temperature data						
Range without humidity (°C / °F)	-5 to 100 /23 to 212	-5 to 100 /23 to 212	-5 to 100 /23 to 212	-5 to 100 /23 to 212	-5 to 100 /23 to 212	-5 to 100 /23 to 212
Fluctuation (±°C / °F) ¹⁾	0.3 / 0.54	0.3 / 0.54	0.3 / 0.54	0.3 / 0.54	0.3 / 0.54	0.3 / 0.54
Variation (±°C / °F) ¹⁾	0.5 / 0.9	0.5 / 0.9	0.5 / 0.9	0.5 / 0.9	0.5 / 0.9	0.5 / 0.9
Heating time (-5°C to 100°C) (min)	50	50	50	55	55	55
Cooling time (100°C to -5°C) (min)	120	120	120	145	145	145
Humidity data (※ Ref.: Temp./ Humid. control range graph)						
Range (%RH)	10 to 95	10 to 95	10 to 95	25 to 95	25 to 95	25 to 95
Fluctuation (±%RH) ¹⁾	2	2	2	2	2	2
Variation (±%RH) ¹⁾	3	3	3	3	3	3
Electrical data & Ordering information						
Electrical requirements (230V, 1ph, 50/60Hz, A)	11.8	13.9	13.9	14.9	14.9	24
Cat. No.	AAHC2002K	AAHC2012K	AAHC2022K	AAHC2032K	AAHC2042K	AAHC2052K

※ The above specifications are tested according to IEC 60068 standard.

※ Permissible environmental conditions are 18 - 30°C (recommended 20°C), 85%RH or less, under 2000m above sea level.

※ The DI water condition is pH 6.2 - 7.2 and the electrical conductivity is less than 20µs/cm.

1) The set value is set under the conditions of 40°C, 60%RH.

Accessories Page 288

Cable Port, Shelves, Signal Lamp, Recorder, Water Purifier, Direct Water System, Inner Glass Door

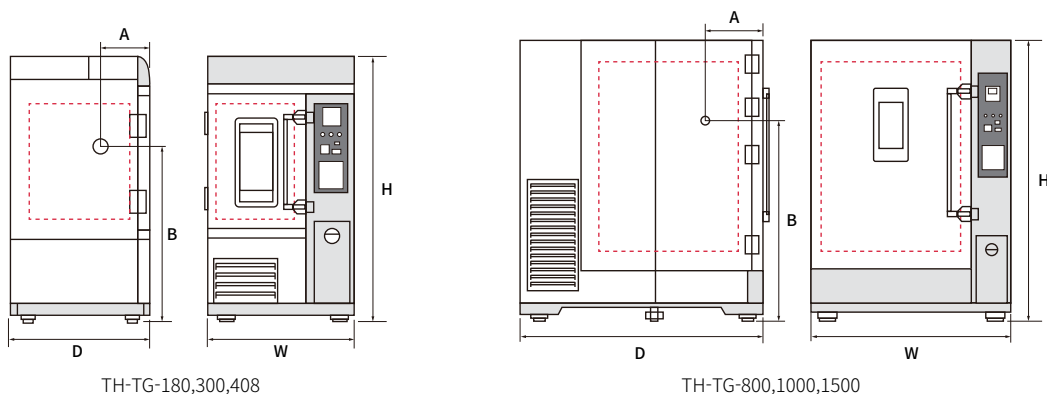

Dimension

Model	TH-TG-180	TH-TG-300	TH-TG-408	TH-TG-800	TH-TG-1000	TH-TG-1500
W (mm / inch)	952 / 37.5	1201 / 47.3	1201 / 47.3	1201 / 47.3	1201 / 47.3	1554 / 61.2
D (mm / inch)	907 / 35.7	907 / 35.7	1107 / 43.6	1228 / 48.3	1498 / 59.0	1872 / 73.7
H (mm / inch)	1503 / 591.7	1525 / 60.0	1525 / 60.0	1993 / 78.5	1993 / 78.5	1935 / 76.2
A (mm / inch)	321 / 12.6	366 / 14.4	366 / 14.4	385 / 15.2	520 / 20.5	447 / 17.6
B (mm / inch)	1004 / 39.5	1016 / 40.0	1016 / 40.0	1335 / 52.6	1335 / 52.6	1384 / 54.5

Temperature & Humidity Chamber

Dual type

Space efficiency model that controls two upper and lower chambers individually



TH-DG-150

with Wire Shelves 2ea Φ 50 Cable Port (standard), Recorder (option)

▮ Optimized For Long-term Testing

- Independent control of the temperature and humidity with dual chambers divided into upper and lower.
- Suitable for use when various test are required.
- Superior defrosting control technology ensures stable temperature and humidity control for long-term tests.
- Recommended in case no low temperature testing.
- Provide 3 kinds of model depending on capacity.
- Satisfies ICH Guideline Q1A (R2) Stability Test.
- Recorder for maintaining test records. (option)

▮ Structural Functional Features

- Optimum temperature and humidity test can be carried out even with minimum refrigeration performance, it makes reduce the electric energy efficiently.
- Excellent thermal insulation and sealing to ensure stable temperature and humidity reproducibility even for repeated test use.
- Proven reproducibility and reliability with structural design optimized for each capacity.
- The door part is a double-sealed structure that provides enhanced airtightness.

Use Convenience Features

- Convenient operation with large color touch display controller.
- Efficient water supply and recirculation system minimizes water refilling even for long-term high-humidity tests.
- Water inlet is easy to use with easy cap.
- Possible structure to refill the water even during operation.
- Direct water supply system. (option)
- Easy observation of samples with tempered glass door with built in heating wire and LED lamp.
- Open/close door with latches on either side.
- Door handle with built-in key lock.
- Cable port (Ø50 mm) is included as standard, making it convenient to connect external equipment.

Multifunction Control System

- Includes temperature and humidity auto-tuning.
- Highly reliable control through temperature calibration.
- PID zone subdivided into 9 zones for more precise control stability.
- RS-232 port (default) and RS-485 port (option) supported.
- Control and data processing by connecting up to 32 devices to PC at same time via RS-485 port.
- Convenient checking with useful graph display.

Description	No.
Pattern	100
Repeat time	999
Part repeat time	255
Max. segments / pattern	100
Available max. segments	2000
Programmable process time / segment	99 hr. 59 min.

* It is possible to set 100 segments per pattern, but the maximum number of segments is not 10,000 (100 pattern x 100 segment) but 2,000.

Outstanding Safety

- Electronic over temperature shutdown system. (advanced over temperature (A-OT) limiter)
Independent precision temperature sensor and controller for safer and more accurate over temperature shutdown.
- General over power shutdown system. (B-OT, backup over temperature limiter)
A backup device for electronic system failure, mechanically preventing over temperature even when it occurs electronic errors.
- Ensures that the surface temperature is kept below 60°C.
- Low and empty water level alarm and automatic shut off.
- Door open warning and automatic shut off.
- Overcurrent and short circuit protection of device.
- Fuse installed for each heater for safety.
- Auto stop when operating current of compressor is overloaded.
- Auto stop when compressor is overheating.
- Auto shut off in case refrigerant pressure (high/low pressure) is abnormal.



Door handle & locking device



Cable Port



Controller

TH-DG

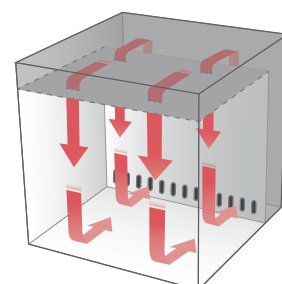
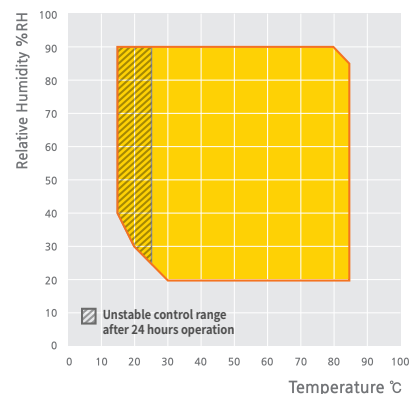



Specification

Model	TH-DG-150	TH-DG-300	TH-DG-400
Interior dimensions			
Chamber volume (L / cu ft)	150 x 2 / 5.3 x 2	288 x 2 / 10.2 x 2	384 x 2 / 13.6 x 2
Width (mm / inch) ²⁾	600 / 23.6	800 / 31.5	800 / 31.5
Depth (mm / inch) ²⁾	500 / 19.7	600 / 23.6	800 / 31.5
Height (mm / inch) ²⁾	500 / 19.7	600 / 23.6	600 / 23.6
Quantity of shelves (standard/max.) ²⁾	2 / 7	2 / 8	2 / 8
Distance of between shelves (mm / inch)	60 / 2.4	60 / 2.4	60 / 2.4
Max. load per shelf (kg / lbs)	25 / 55.1	25 / 55.1	25 / 55.1
Permitted total load (kg / lbs) ²⁾	75 / 165.3	75 / 165.3	75 / 165.3
Cable port (Ø, mm / inch) ²⁾	50 / 2.0	50 / 2.0	50 / 2.0
Water tank capacity (L / cu ft)	20 / 0.7	24 / 0.8	24 / 0.8
Weight (kg / lbs)	420 / 926	516 / 1137.6	560 / 1234.6
Temperature data			
Range without humidity (°C / °F)	-5 to 100	-5 to 100	-5 to 100
Fluctuation (±°C / °F) ¹⁾	0.3 / 0.54	0.3 / 0.54	0.3 / 0.54
Variation (±°C / °F) ¹⁾	0.5 / 0.9	0.5 / 0.9	0.5 / 0.9
Heating time (-5°C to 100°C) (min)	85	85	85
Cooling time (100°C to -5°C) (min)	100	100	100
Humidity data (※ Ref.: Temp./ Humid. control range graph)			
Range (%RH)	20 to 90	20 to 90	20 to 90
Fluctuation (±%RH) ¹⁾	0.8	0.8	0.8
Variation (±%RH) ¹⁾	3	3	3
Electrical data & Ordering information			
Electrical requirements (230V, 1ph, 50/60Hz, A)	13.0 x 2ea	16.8 x 2ea	16.8 x 2ea
Cat. No.	AAHC6002K	AAHC6012K	AAHC6022K

※ The above specifications are tested according to IEC 60068 standard.

※ Permissible environmental conditions are 18 - 30°C (recommended 20°C), 85%RH or less, under 2000m above sea level.

※ The DI water condition is pH 6.2 - 7.2 and the electrical conductivity is less than 20µs/cm.

1) The set value is set under the conditions of 40°C, 75%RH.

2) Each chamber.

Accessories Page 288

Cable Port, Shelves, Signal Lamp, Recorder, Water Purifier, Direct Water System, Inner Glass Door

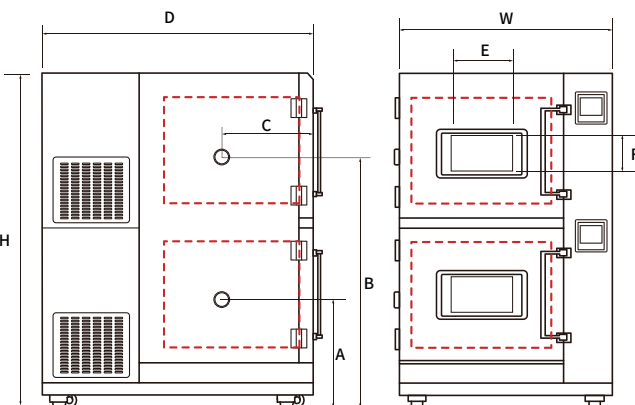

Dimension

Model	TH-DG-150	TH-DG-300	TH-DG-400
W (mm / inch)	1055 / 41.5	1255 / 49.4	1255 / 49.4
D (mm / inch)	1320 / 52.0	1470 / 57.9	1670 / 65.9
H (mm / inch)	1725 / 67.9	1925 / 75.8	1925 / 75.8
A (mm / inch)	710 / 28.0	760 / 29.9	760 / 29.9
B (mm / inch)	1450 / 57.1	1600 / 63.0	1600 / 63.0
C (mm / inch)	345 / 13.6	385 / 15.2	485 / 19.1
E (mm / inch)	330 / 13.0	330 / 13.0	330 / 13.0
F (mm / inch)	200 / 7.9	200 / 7.9	200 / 7.9

Temperature & Humidity Chamber

Basic type

Applied the new developed controller specialized for Temp. & Humid chambers

▣ Differentiated Systems

- Convenient operation with 5.6 inch color touch display controller.
- Possible to check the operation status with graphs.
- Minimize the occurrence of faults by simplifying water direct line and electric circuit.
- Water level check function enables water replenishment at the right time.

▣ Structural Functional Features

- Excellent thermal insulation and sealing to ensure stable temperature and humidity reproducibility even for repeated test use.
- The door part is a double-sealed structure that provides enhanced airtightness.
- Maintains stable temperature and humidity by circulating air in the chamber at the optimum speed.
- Energy-saving system that can perform optimum temperature and humidity tests efficiently, reducing power consumption during operation.



TH3-E-200
with Wire Shelves 2ea (standard)

▣ Outstanding Safety

- Electronic over temperature shutdown system.
(advanced over temperature (A-OT) limiter)
Independent precision temperature sensor and controller for safer and more accurate over temperature shutdown.
- General over power shutdown system.
(B-OT, backup over temperature limiter)
A backup device for electronic system failure, mechanically preventing over temperature even when it occurs electronic errors.
- Ensures that the surface temperature is kept below 60°C.
- Low and empty water level alarm and automatic shut off.
- Door open warning and automatic shut off.
- Overcurrent and short circuit protection of device.
- Fuse installed for each heater for safety.
- Auto stop when operating current of compressor is overloaded.
- Auto stop when compressor is overheating.
- Auto shut off in case refrigerant pressure (high/low pressure) is abnormal.

TH3-E-200, 400

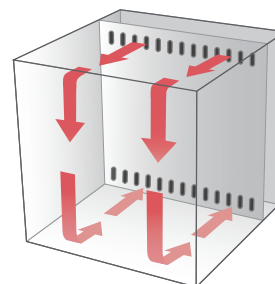
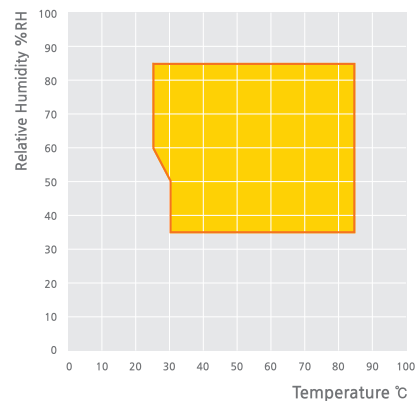



Use Convenience Features

- Efficient water supply and recirculation system minimizes water refilling even for long-term high-humidity tests.
- Direct water supply system. (option)
- Easy observation of samples with tempered glass door with built in heating wire and LED lamp.
- A structure that allows the door to be opened and closed easily.
- Easy to clean as it is easy to remove refrigerator condenser grill, making it convenient to maintain efficiency of refrigeration.

Multifunction Control System

- Reliable control with temperature/humidity auto-tuning and temperature calibration.
- Control and data processing by connecting up to 32 devices to PC at same time via RS-485 port.
- PID zone subdivided into 9 zones for more precise control stability.
- Monitor via mobile app anytime, anywhere with LC Connected. (mobile monitoring system) (when purchased LC GreenBox)
- Convenient checking with useful graph display.

Description	No.
Pattern	100
Repeat time	999
Part repeat time	255
Max. segments / pattern	100
Available max. segments	2000
Programmable process time / segment	99 hr. 59 min.

* It is possible to set 100 segments per pattern, but the maximum number of segments is not 10,000 (100 pattern x 100 segment) but 2,000.



Large LCD touch screen controller (5.6 inches)



Tempered glass window with wire heater and LED lamp

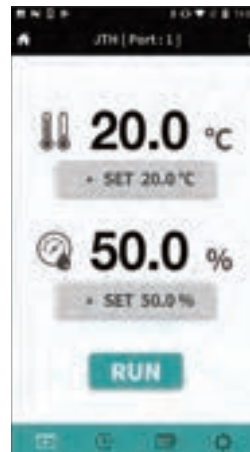

Remote monitoring and control via Lab Companion's app.

Specification

Model	TH3-E-200	TH3-E-400
Interior dimensions		
Chamber volume (L / cu ft)	201 / 7.1	398 / 14.1
Width (mm / inch)	500 / 19.7	600 / 23.6
Depth (mm / inch)	670 / 26.4	830 / 32.7
Height (mm / inch)	600 / 23.6	800 / 31.5
Quantity of shelves (standard/max.)	2 / 9	2 / 10
Distance of between shelves (mm)	40 / 1.6	40 / 1.6
Max. load per shelf (kg / lbs)	20 / 44.1	25 / 55.1
Permitted total load (kg / lbs)	50 / 110.2	65 / 143.3
Cable port (∅, mm / inch)	50 / 2.0	50 / 2.0
Water tank capacity (L / cu ft)	20 / 0.7	20 / 0.7
Weight (kg / lbs)	200 / 440.9	270 / 595.2
Temperature data		
Range without humidity (°C / °F)	0 to 90 / 32 to 194	0 to 90 / 32 to 194
Fluctuation (±°C / °F) ¹⁾	0.5 / 0.9	0.5 / 0.9
Variation (±°C / °F) ¹⁾	0.8 / 1.44	0.8 / 1.44
Heating time (0°C to 90°C) (min)	80	80
Cooling time (90°C to 0°C) (min)	90	90
Humidity data (※ Ref.: Temp./ Humid. control range graph)		
Range (%RH)	35 to 85	35 to 85
Fluctuation (±%RH) ¹⁾	1	1
Variation (±%RH) ¹⁾	3	3
Electrical data & Ordering information		
Electrical requirements (230V, 1ph, 50/60Hz, A)	15	16
Cat. No.	AAH841102K	AAH841112K

※ The above specifications are tested according to IEC 60068 standard.

※ Permissible environmental conditions are 18 - 30°C (recommended 20°C), 85%RH or less, under 2000m above sea level.

※ The DI water condition is pH 6.2 - 7.2 and the electrical conductivity is less than 20µs/cm.

1) The set value is set under the conditions of 40°C, 75%RH.

Accessories Page 288

Cable Port, Shelves, Signal Lamp, Recorder, Water Purifier, Direct Water System, Inner Glass Door, LC GreenBox

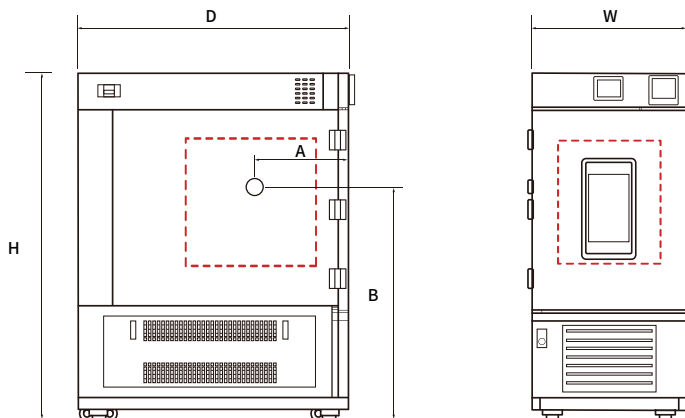

Dimension

Model	TH3-E-200	TH3-E-400
W (mm / inch)	655 / 25.8	755 / 29.7
H (mm / inch)	1495 / 58.9	1695 / 66.7
D (mm / inch)	1162 / 45.7	1322 / 52.0
A (mm / inch)	375 / 14.8	455 / 17.9
B (mm / inch)	985 / 38.8	1135 / 44.7

Pharmaceutical Stability Test Chamber

Satisfies ICH Guideline Q1A (R2) & Q1B(Option 2) Test



TH-ICH-800

with Wire Shelves 2ea, Φ 50 Cable Port (standard), Recorder (option)

TH-ICH-300

with Wire Shelves 2ea, Φ 50 Cable Port (standard), Recorder (option)

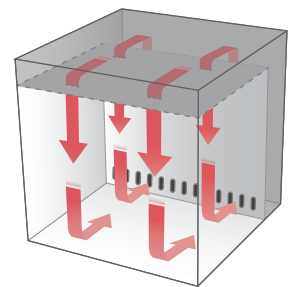
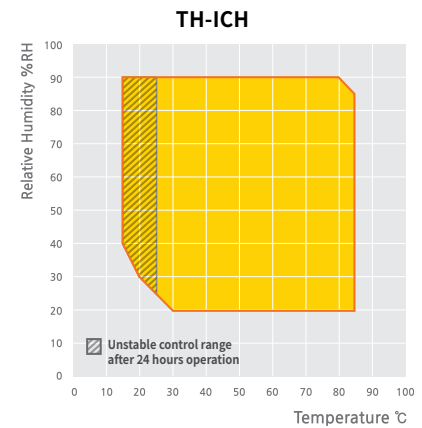

▣ Stability Test (ICH Guideline Q1A (R2))

- Ease of data analysis with useful graphical shows.
- Superior defrosting control technology ensures stable temperature and humidity control for long-term tests.
- Drawer-type water tank structure makes refill the water easily at the front part.
- Possible structure to refill the water even during operation.
- Direct water supply system. (option)
- Recorder for maintaining test records. (option)
- Inner glass door allows for convenient internal observation during long-term testing and sample access during testing. (option)

▣ Photostability Test

- Built-in cool white fluorescent lamp and UVA lamp.
- Visible light sensor and UV sensor included as standard.
- Dedicated controller for light cumulative dose setting/control.
- Convenient management by displaying the usage time for each lamp.

▣ Structural Functional Features

- Optimum temperature and humidity test can be carried out even with minimum refrigeration performance, it makes reduce the electric energy efficiently.
- Excellent thermal insulation and sealing to ensure stable temperature and humidity reproducibility even for repeated test use.
- Proven reproducibility and reliability with structural design optimized for each capacity.
- The door part is a double-sealed structure that provides enhanced airtightness.

Use Convenience Features

- Convenient operation with 3.7 inch color touch display controller.
- A structure that allows the door to be opened and closed easily.
- Door handle with built-in key lock.
- Cable port (Ø50 mm) is included as standard, making it convenient to connect external equipment.
- Easy to clean as it is easy to remove refrigerator condenser grill, making it convenient to maintain efficiency of refrigeration.



Built-in cool white fluorescent lamp and UVA lamp

Structural Functional Features

- Fix control and program control are selectable.
- Process time displayable.
- Includes temperature and humidity auto-tuning.
- Highly reliable control through temperature calibration.
- PID zone subdivided into 9 zones for more precise control stability.
- RS-232 port (default) and RS-485 port (option) supported.
- Control and data processing by connecting up to 32 devices to PC at same time via RS-485 port.



Drawer type of water tank

Outstanding Safety

- Electronic over temperature shutdown system.
(advanced over temperature (A-OT) limiter)
Independent precision temperature sensor and controller for safer and more accurate over temperature shutdown.
- General over power shutdown system.
(B-OT, backup over temperature limiter)
A backup device for electronic system failure, mechanically preventing over temperature even when it occurs electronic errors.
- Ensures that the surface temperature is kept below 60°C.
- Low and empty water level alarm and automatic shut off.
- Door open warning and automatic shut off.
- Overcurrent and short circuit protection of device.
- Fuse installed for each heater for safety.
- Auto stop when operating current of compressor is overloaded.
- Auto stop when compressor is overheating.
- Auto shut off in case refrigerant pressure (high/low pressure) is abnormal.



UV / VIS sensor



Lamp controller

Description	No.
Pattern	100
Repeat time	999
Part repeat time	255
Max. segments / pattern	100
Available max. segments	2000
Programmable process time / segment	99 hr. 59 min.

* It is possible to set 100 segments per pattern, but the maximum number of segments is not 10,000 (100 pattern x 100 segment) but 2,000.



Controller



Specification

Model	TH-ICH-300	TH-ICH-800
Interior dimensions		
Chamber volume (L / cu ft)	300 / 10.6	760 / 26.8
Width (mm / inch)	750 / 29.5	750 / 29.5
Depth (mm / inch)	650 / 25.6	880 / 34.6
Height (mm / inch)	650 / 25.6	1160 / 45.7
Quantity of shelves (standard/max.)	2 / 8	2 / 17
Distance of between shelves (mm / inch)	60 / 2.4	60 / 2.4
Max. load per shelf (kg / lbs)	25 / 55.1	40 / 88.2
Permitted total load (kg / lbs)	75 / 165.3	100 / 220.5
Cable port (∅, mm / inch)	50 / 2.0	50 / 2.0
Water tank capacity (L / cu ft)	15 / 0.5	15 / 0.5
Weight (kg / lbs)	280 / 617.3	400 / 881.8
Temperature data		
Range without humidity (°C / °F)	-5 to 85 / 23 to 185	-5 to 85 / 23 to 185
Fluctuation (±°C / °F) ¹⁾	0.3 / 0.54	0.3 / 0.54
Variation (±°C / °F) ¹⁾	0.5 / 0.9	0.7 / 1.26
Heating time (20°C to 85°C) (min)	25	30
Cooling time (20°C to -5°C) (min)	35	40
Humidity data (※ Ref.: Temp./ Humid. control range graph)		
Range (%RH)	20 to 85	20 to 85
Fluctuation (±%RH) ¹⁾	3	3
Variation (±%RH) ¹⁾	5	5
Light data (ICH Q1B option 2)		
Cool white (Lux)	6000	6500
Ultraviolet-A (W/m ²)	4.5	5
Uniformity of Visible light (±%)	10	15
Uniformity of Ultraviolet-A light (±%)	15	15
Typical time 1.2 million Lux-hr (hr)	200	184
Typical time 200 W-hr/m ² (hr)	50	40
Electrical data & Ordering information		
Electrical requirements (230V, 1ph, 50/60Hz, A)	14.7	23.5
Cat.No.	AAHC1002K	AAHC1012K

※ The above specifications are tested according to IEC 60068 standard.

※ Permissible environmental conditions are 18 - 30°C (recommended 20°C), 85%RH or less, under 2000m above sea level.

※ The DI water condition is pH 6.2 - 7.2 and the electrical conductivity is less than 20µs/cm.

1) The set value is set under the conditions of 40°C, 60%RH.

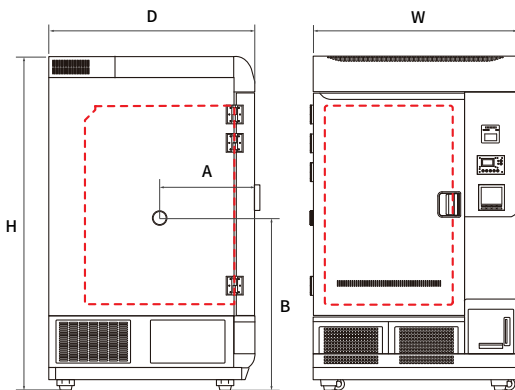

Dimension

Model	TH-ICH-300	TH-ICH-800
W (mm / inch)	1130 / 44.5	1220 / 48.0
D (mm / inch)	985 / 38.8	1215 / 47.8
H (mm / inch)	1520 / 59.8	1955 / 77.0
A (mm / inch)	460 / 18.1	545 / 21.5
B (mm / inch)	905 / 35.6	1185 / 46.7

Accessories [Page 288](#)

Cable Port, Shelves, Signal Lamp, Recorder, Water Purifier, Direct Water System, Inner Glass Door

Accessories

Wire Shelf



- Excellent ventilation structure.
- Stainless steel.
- Includes 2ea as standard.

Perforated Shelf



- Suitable for high-load samples.
- Excellent maintenance as made of stainless steel.

Recorder (Paper)



- Up to 6 channels supported.
- Set recording range and speed.
- Paper width: 100 mm.

Recorder (Digital)

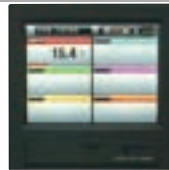

- Paperless. (5.7" LCD display)
- Up to 6 channels supported.
- Data stored in internal/external memory.

Cable Port



- Both cap and silicone plug are included as standard in Ø50 mm cable port.
- It is available to add Ø50 mm, Ø80 mm.

Signal Lamp



- Figuring out equipment status remotely.
- Run/Stand-by/Error displayed by color.

Water Purifier



- Water purifier composed of particle filter and carbon filter.
- Solid steel box construction.

Inner Glass Door



- Minimized temperature and humidity changes and observation of internal samples enabled.
- Hand-in port is provided as standard. (selectable when purchasing)

Stand (1 Stage)



- Dedicated stand for small appliances.
- Provides lower drawer and loading space.
- Casters provided as standard for moving/fixing.

Stand (2 Stage)



- Placing of two compact devices vertically.
- Minimized installation space for different temperature and humidity tests.

LC GreenBox (only TH3 model)



- Real-time monitoring of device operation via mobile app.
- Up to 4 devices can be connected.

Direct Water System



- Direct connection of distilled water to direct water line of the equipment from a water supply pipe.
- Useful for long-term testing.

Model	Cable Port (ø50)	Cable Port (ø80)	Wire Shelf	Perforated Shelf	Signal Lamp	Recorder (Paper)	Recorder (Digital)	Water Purifier	Direct Water System	Inner Glass Door	Stand (1 stage)	Stand (2 stage)
TH3-KE-025	AAA8T612	N/A	00RTD0000679	AAA80602-6	AAA80550	AAA8T504	AAA8T506	AAA8T625	AAA80620	N/A	AAA80631	AAA80634
TH3-KE-065	AAA8T612	AAA8T611	00RTD0000680	AAA80602-7	AAA80550	AAA8T504	AAA8T506	AAA8T625	AAA80620	N/A	AAA80632	AAA80635
TH3-KE-100	AAA8T612	AAA8T611	00RTD0000681	AAA80602-8	AAA80550	AAA8T504	AAA8T506	AAA8T625	AAA80620	N/A	AAA80633	N/A
TH3-ME-025	AAA8T612	N/A	00RTD0000679	AAA80602-6	AAA80550	AAA8T504	AAA8T506	AAA8T625	AAA80620	N/A	AAA80631	AAA80634
TH3-ME-065	AAA8T612	AAA8T611	00RTD0000680	AAA80602-7	AAA80550	AAA8T504	AAA8T506	AAA8T625	AAA80620	N/A	AAA80632	AAA80635
TH3-ME-100	AAA8T612	AAA8T611	00RTD0000681	AAA80602-8	AAA80550	AAA8T504	AAA8T506	AAA8T625	AAA80620	N/A	AAA80633	N/A
TH3-PE-025	AAA8T612	N/A	00RTD0000679	AAA80602-6	AAA80550	AAA8T504	AAA8T506	AAA8T625	AAA80620	N/A	AAA80631	AAA80634
TH3-PE-065	AAA8T612	AAA8T611	00RTD0000680	AAA80602-7	AAA80550	AAA8T504	AAA8T506	AAA8T625	AAA80620	N/A	AAA80632	AAA80635
TH3-PE-100	AAA8T612	AAA8T611	00RTD0000681	AAA80602-8	AAA80550	AAA8T504	AAA8T506	AAA8T625	AAA80620	N/A	AAA80633	N/A
TH-KH-180	AAA8T610	AAA8T6111	00EDA0008212	AAA80602-1	AAA80550	AAA8T500	AAA8T505	AAA8T625	AAA80620	AAA81552	N/A	N/A
TH-KH-300	AAA8T610	AAA8T6111	00EDA0008213	AAA80602-2	AAA80550	AAA8T500	AAA8T505	AAA8T625	AAA80620	AAA81551	N/A	N/A
TH-KH-408	AAA8T610	AAA8T6111	00EDA0008214	AAA80602-3	AAA80550	AAA8T500	AAA8T505	AAA8T625	AAA80620	AAA81551	N/A	N/A
TH-G-180	AAA8T610	AAA8T611	00EDA0008212	AAA80602-1	AAA80550	AAA8T500	AAA8T505	AAA8T625	AAA80620	AAA81552	N/A	N/A
TH-G-300	AAA8T610	AAA8T611	00EDA0008213	AAA80602-2	AAA80550	AAA8T500	AAA8T505	AAA8T625	AAA80620	AAA81551	N/A	N/A
TH-G-408	AAA8T610	AAA8T611	00EDA0008214	AAA80602-3	AAA80550	AAA8T500	AAA8T505	AAA8T625	AAA80620	AAA81551	N/A	N/A
TH-G-800	AAA8T610	AAA8T611	00EDA0008215	AAA80602-4	AAA80550	AAA8T500	AAA8T505	AAA8T625	AAA80620	AAA81550	N/A	N/A
TH-G-1000	AAA8T610	AAA8T611	00EDA0008216	AAA80602-5	AAA80550	AAA8T500	AAA8T505	AAA8T625	AAA80620	AAA81550	N/A	N/A
TH-G-1500	AAA8T610	AAA8T611	00EDA0008216	AAA80602-5	AAA80550	AAA8T500	AAA8T505	AAA8T625	AAA80620	N/A	N/A	N/A
TH-TG-180	AAA8T610	AAA8T611	00RTD0001302	AAA80604-11	AAA80550	AAA8T500	AAA8T505	AAA8T625	AAA80620	AAAC2501	N/A	N/A
TH-TG-300	AAA8T610	AAA8T611	00RTD0001303	AAA80604-12	AAA80550	AAA8T500	AAA8T505	AAA8T625	AAA80620	AAAC2502	N/A	N/A
TH-TG-408	AAA8T610	AAA8T611	00RTD0001300	AAA80604-13	AAA80550	AAA8T500	AAA8T505	AAA8T625	AAA80620	AAAC2502	N/A	N/A
TH-TG-800	AAA8T610	AAA8T611	00RTD0001304	AAA80604-14	AAA80550	AAA8T500	AAA8T505	AAA8T625	AAA80620	AAAC2503	N/A	N/A
TH-TG-1000	AAA8T610	AAA8T611	00RTD0001301	AAA80604-15	AAA80550	AAA8T500	AAA8T505	AAA8T625	AAA80620	AAAC2503	N/A	N/A
TH-TG-1500	AAA8T610	AAA8T611	00RTD0001305	AAA80604-16	AAA80550	AAA8T500	AAA8T505	AAA8T625	AAA80620	N/A	N/A	N/A
TH-DG-150	AAA8T610	AAA8T611	00EDA0008251	AAAC6501	AAA80550	AAA8T500	AAA8T505	AAA8T625	AAA80620	AAAC6511	N/A	N/A
TH-DG-300	AAA8T610	AAA8T611	00RTD0001280	AAAC6502	AAA80550	AAA8T500	AAA8T505	AAA8T625	AAA80620	AAAC6512	N/A	N/A
TH-DG-400	AAA8T610	AAA8T611	00EDA0008250	AAAC6503	AAA80550	AAA8T500	AAA8T505	AAA8T625	AAA80620	AAAC6513	N/A	N/A
TH3-E-200	AAA8T610	AAA8T611	00EDA0008212	AAA80602-1	AAA80550	AAA8T500	AAA8T505	AAA8T625	AAA80620	AAA81552	N/A	N/A
TH3-E-400	AAA8T610	AAA8T611	00EDA0008214	AAA80602-3	AAA80550	AAA8T500	AAA8T505	AAA8T625	AAA80620	AAA81551	N/A	N/A
TH-ICH-300	AAA8T610	AAA8T611	00RTD0001196	AAA80604-2	AAA80550	AAA8T500	AAA8T505	AAA8T625	AAA80620	AAA81554	N/A	N/A
TH-ICH-800	AAA8T610	AAA8T611	00RTD0001198	AAA80604-4	AAA80550	AAA8T500	AAA8T505	AAA8T625	AAA80620	AAA81555	N/A	N/A

LC GreenBox

- Monitor and control the operation status of the product in real time via mobile app with an internet connection.

Model	Description	Dimension (mm / inch)	Cat. No.
TH3 series	Mobile Monitoring System	156 x 94 x 34 / 6.1 x 3.7 x 1.3	AAHQ1011K